

FINE QUALITY FOLDERS
T.R. OVEREYNDER
KNIVES
ARLINGTON, TX.

1800 So. Davis Drive
Arlington, TX 76013



T.R. Overeynder
(817) 277-4812

AMERICAN CRAFTSMEN ARE ALIVE IN AMERICA

Dear Customer/Collector:

Subject: An Introduction to TRO Knives and My Ethics Concerning My Business of Handmade Knives

My knife business started in 1979 as I made my first folding knife, an integral titanium frame lockback.

I believe now, as I did then, that I must have 100% control over my business and processes. With one or two exceptions: 1) I do not engrave or scrimshaw, 2) I do not like to do leatherwork, but I do it at times. So, these items are left to very expert craftsmen to do.

I don't out source work to outside shops, as many makers now do (as in laser cutting, water jet, E.D.M, blade grinding, frame cutting, the list goes on). My customers can rest assured that a knife purchased from me was 100% handmade by me in my shop.

Yes, I do use machine tools in my processes. However, they are all manual types which I must set-up using my skills as an accomplished machinist. Machines simply allow me to get the bulk out of the way, i.e. stock sizing, etc. All cuts made by a machine on a TRO knife must be hand finished to achieve the fit and finish you, as my discriminating customers, demand and deserve to receive.

It is not unusual to invest 25-30 hours or more of labor in each knife and with today's cost for pearl, mammoth ivory, Damascus, etc., anywhere from \$100 - \$600 in materials can be required for a quality knife. There are also other overhead costs that come with any business operation. All together it does become expensive, which is all the more reason when you read my logo, you can be assured I've made the best knife, with the finest materials and best effort at that given time.

There are many very fine craftsmen, who do business the way I do and they too are worthy of your business. However, there is a growing segment who will deceive you and not tell you the truth that you deserve to know. Who really made the knife that you have invested a large amount of money in? An educated collector is a wise buyer.

I want to thank you, my customers, for the success I have enjoyed in today's very competitive field of knifemaking.

With Best Regards,



T. R. Overeynder, Knifemaker

FINE QUALITY FOLDERS

T.R. OVEREYNDER

KNIVES
ARLINGTON, TX.

1800 So. Davis Drive
Arlington, TX 76013



T.R. Overeynder (817) 277-4812 FAX 817-~~800-5485~~

AMERICAN CRAFTSMEN ARE ALIVE IN AMERICA

DEC. '90

PG. 1

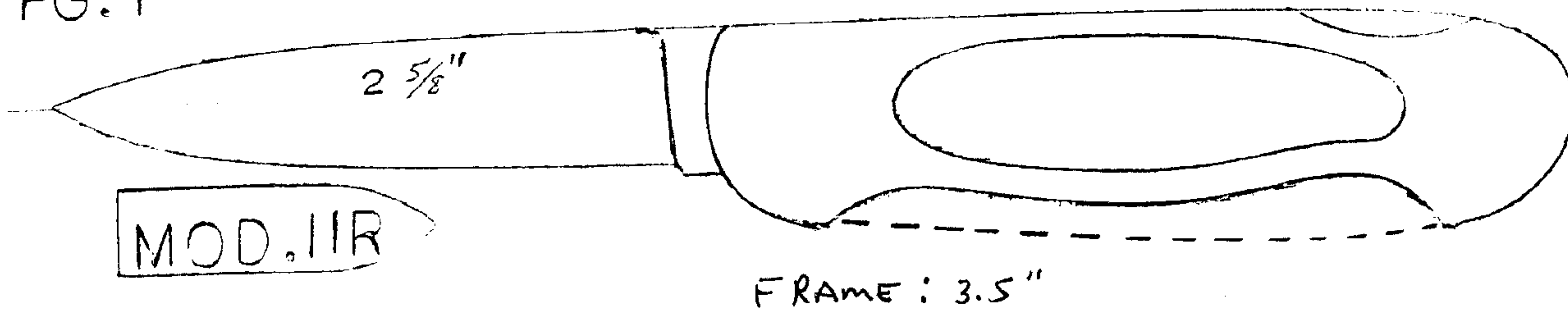

6" CAL

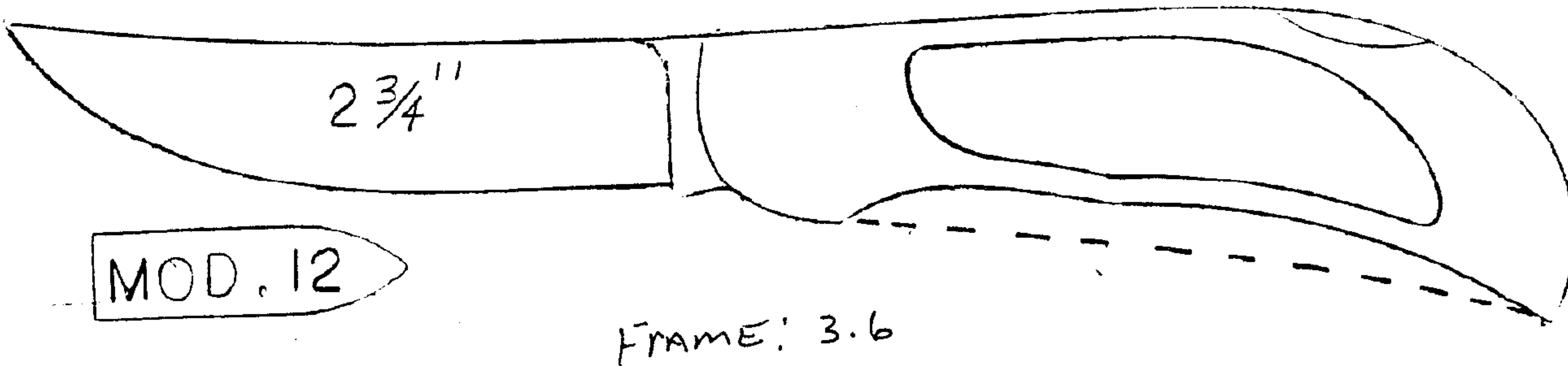
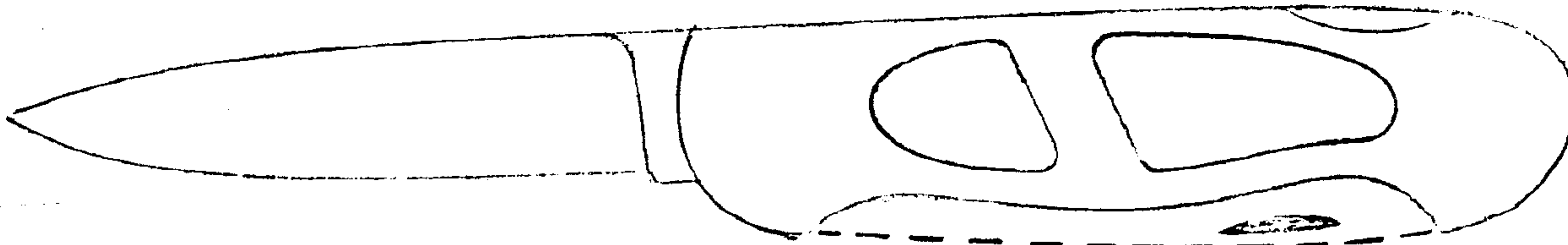

6 1/4" CAL

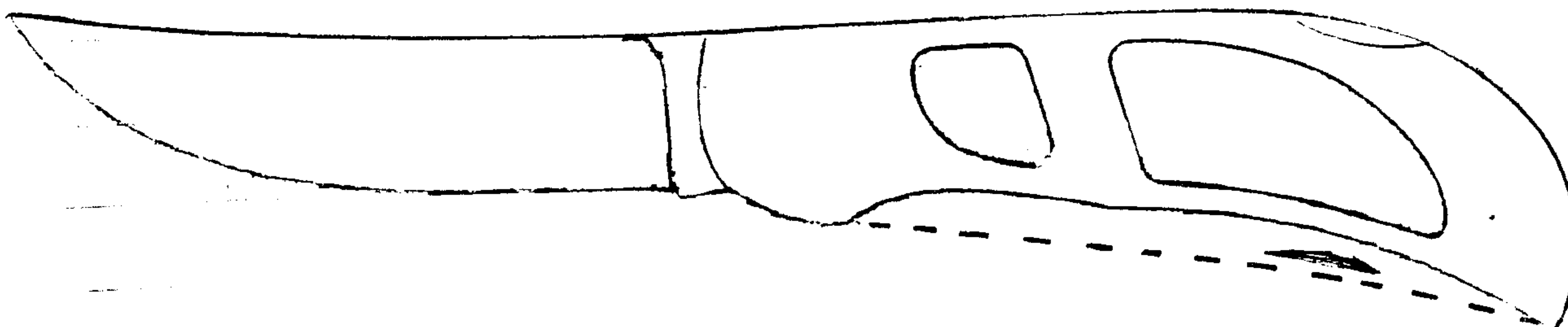

NOTICE: ALL MODELS CAN BE MADE NON-INTERFRAME, IE. WITH BOLSTERS OR IN UTILITY STYLE WITH NO INLAYS OR BOLSTERS.

FINE QUALITY FOLDERS
T.R. OVEREYNDER

KNIVES
ARLINGTON, TX.

1800 So. Davis Drive
Arlington, TX 76013



T.R. Overeynder
(817) 277-4812

+ FAX 1

AMERICAN CRAFTSMEN ARE ALIVE IN AMERICA

PG. 2

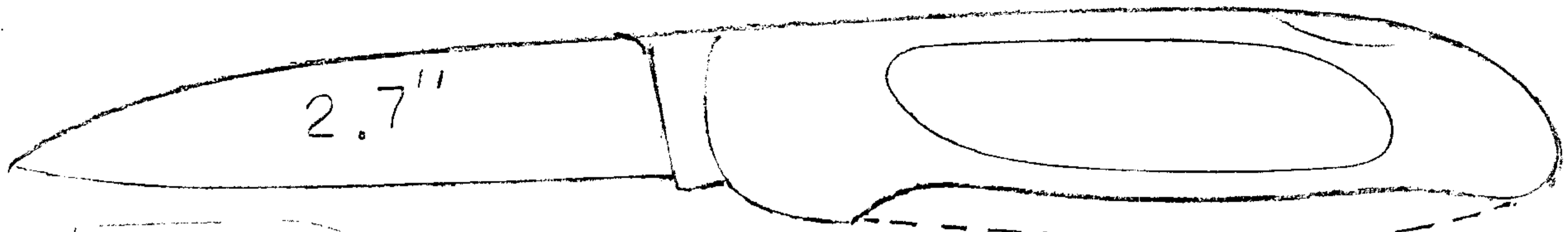

MOD. 13

FRAME: 3.44

6 1/8" CAL.

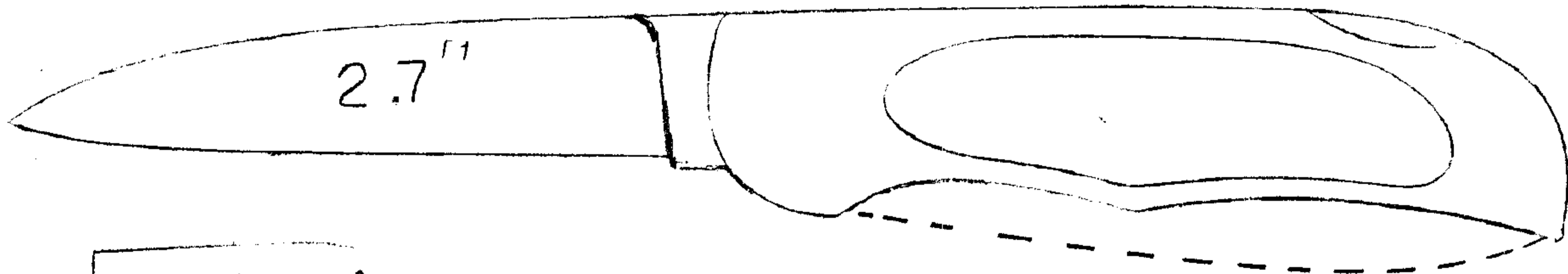
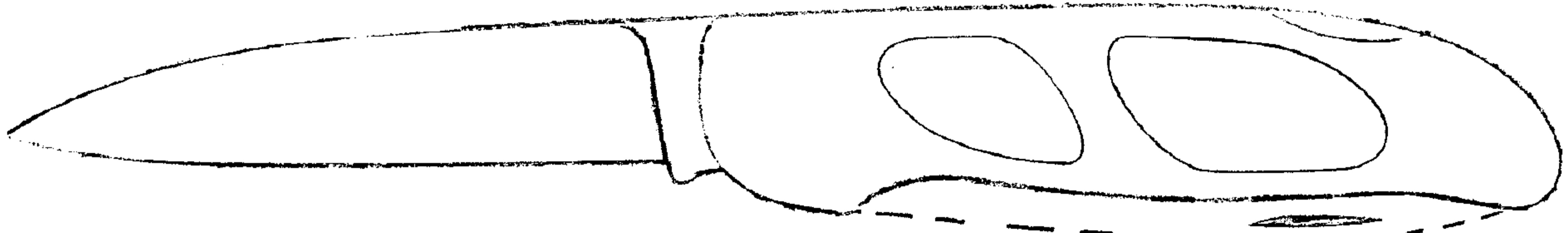

MOD. 14

2 BLADE STYLES

FRAME: 3.44

6" CAL.

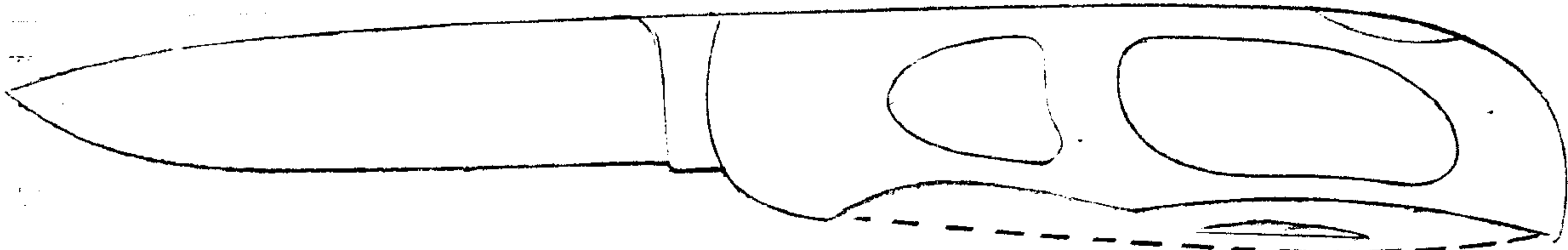

FINE QUALITY FOLDERS

T.R. OVEREYNDER

KNIVES
ARLINGTON, TX.

PG. 3

1800 So. Davis Drive
Arlington, TX 76013



T.R. Overeynder
(817) 277-4812

FAX

AMERICAN CRAFTSMEN ARE ALIVE IN AMERICA

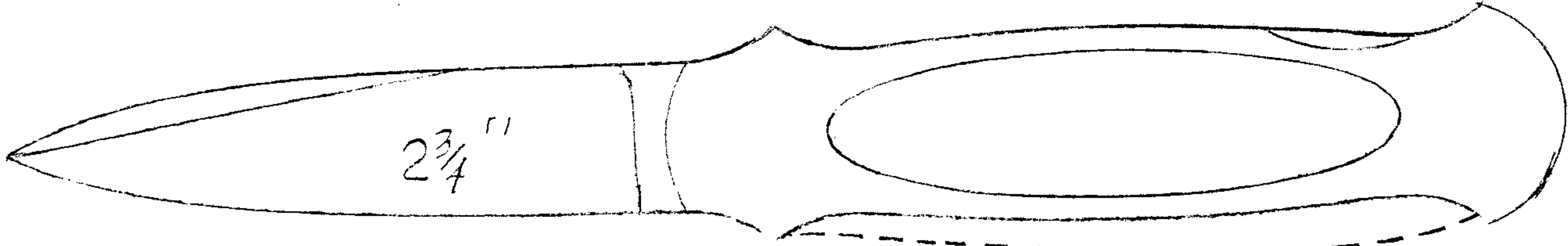
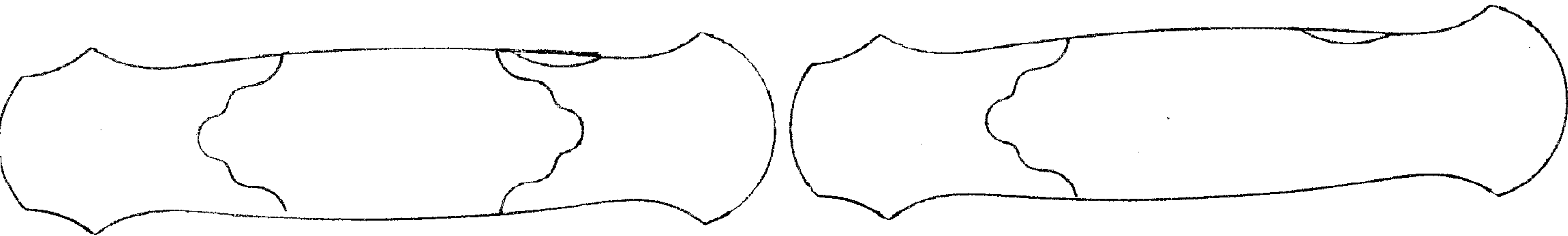

MOD. 15

FRAME 3.8"

6 7/16" CAL.

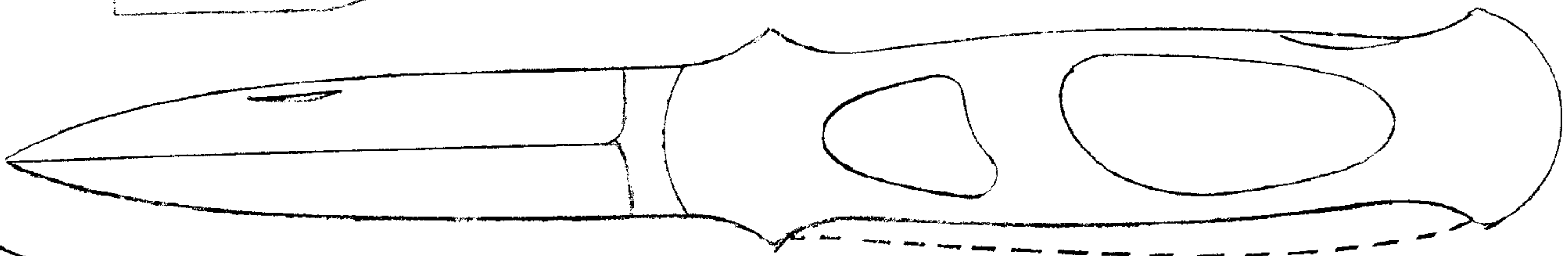

MOD 16

NEW IN '97

9 3/16" OAL.

FRAME 5.25"

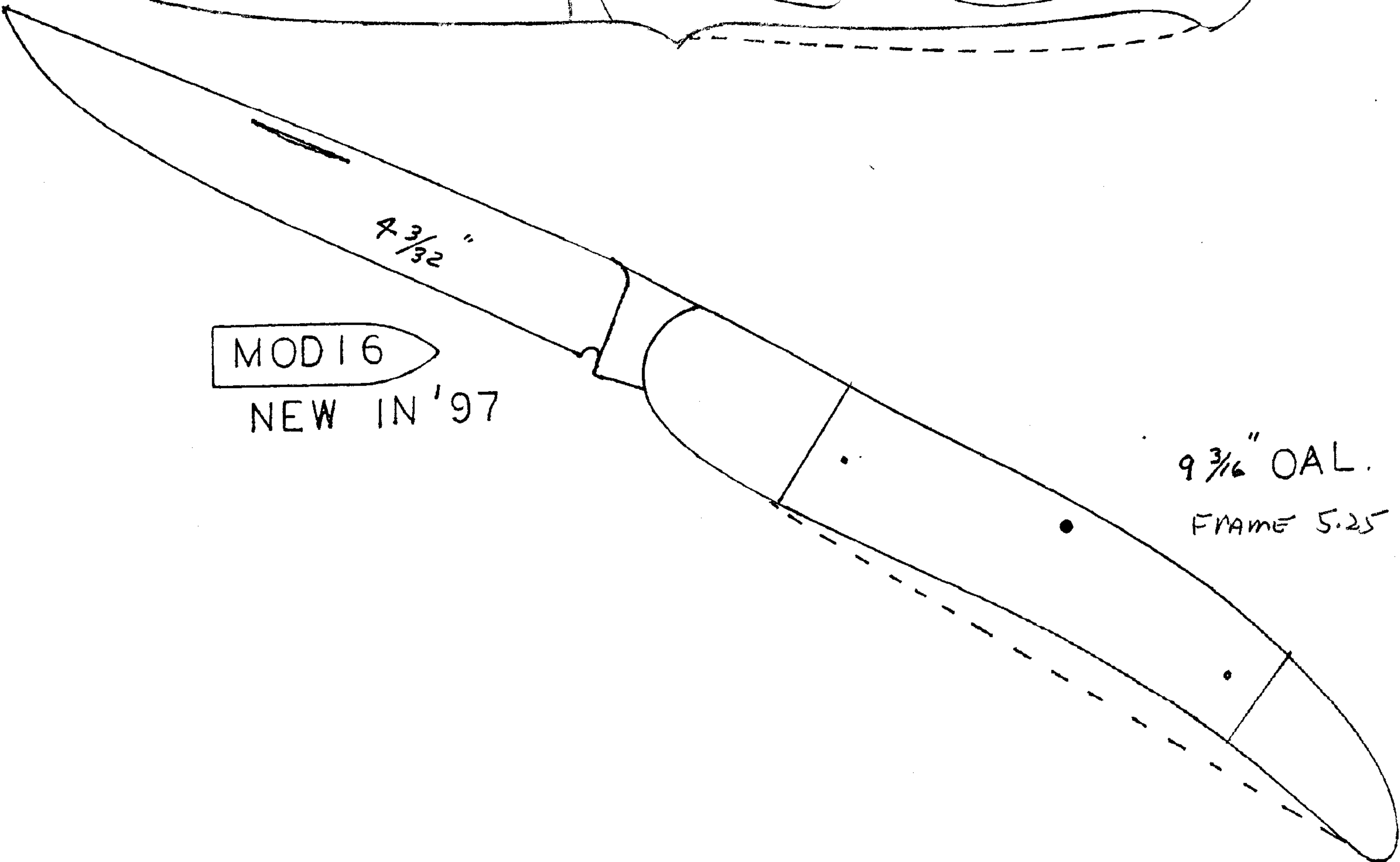

FINE QUALITY FOLDERS
T.R. OVEREYNDER

KNIVES
ARLINGTON, TX.

1800 So. Davis Drive
Arlington, TX 76013



T.R. Overeynder
(817) 277-4812

AMERICAN CRAFTSMEN ARE ALIVE IN AMERICA

PG. 4

SLIP JOINT

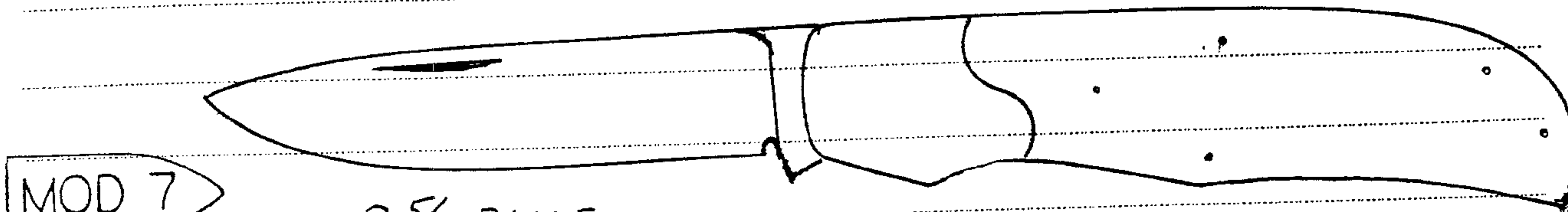

MOD 7

2 5/8 BLADE

BOLSTER

FRAME 3.75

5.9 O.A.L

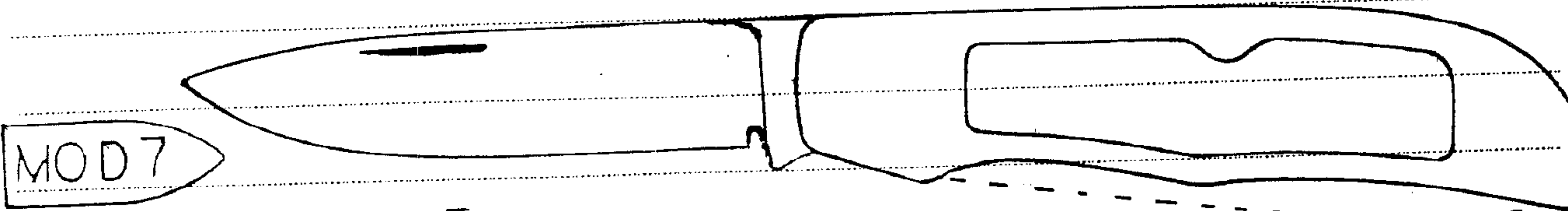

MOD 7

INTERFRAME

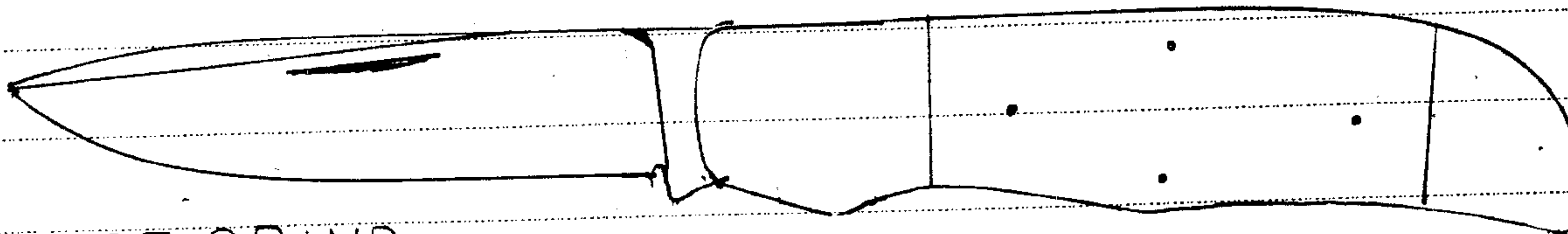

SWAGE GRIND

DOUBLE BOLSTER

T. R. OVEREYNDER
1300 SO. DAVIS DR.
ARLINGTON, TX. 76013

← MOD 15-4 1/4"
1995

BLADE : 4 1/4"

FRAME : 5.7

O.A.L. : 10"

MOD 3-4 1/4" →

BLADE : 4 1/4"

FRAME : 5.2

O.A.L. : 9.5"

← OPTIONAL
BLADE GRIND

INTERFRAME

← DOUBLE BOLSTER

← SINGLE BOLSTER

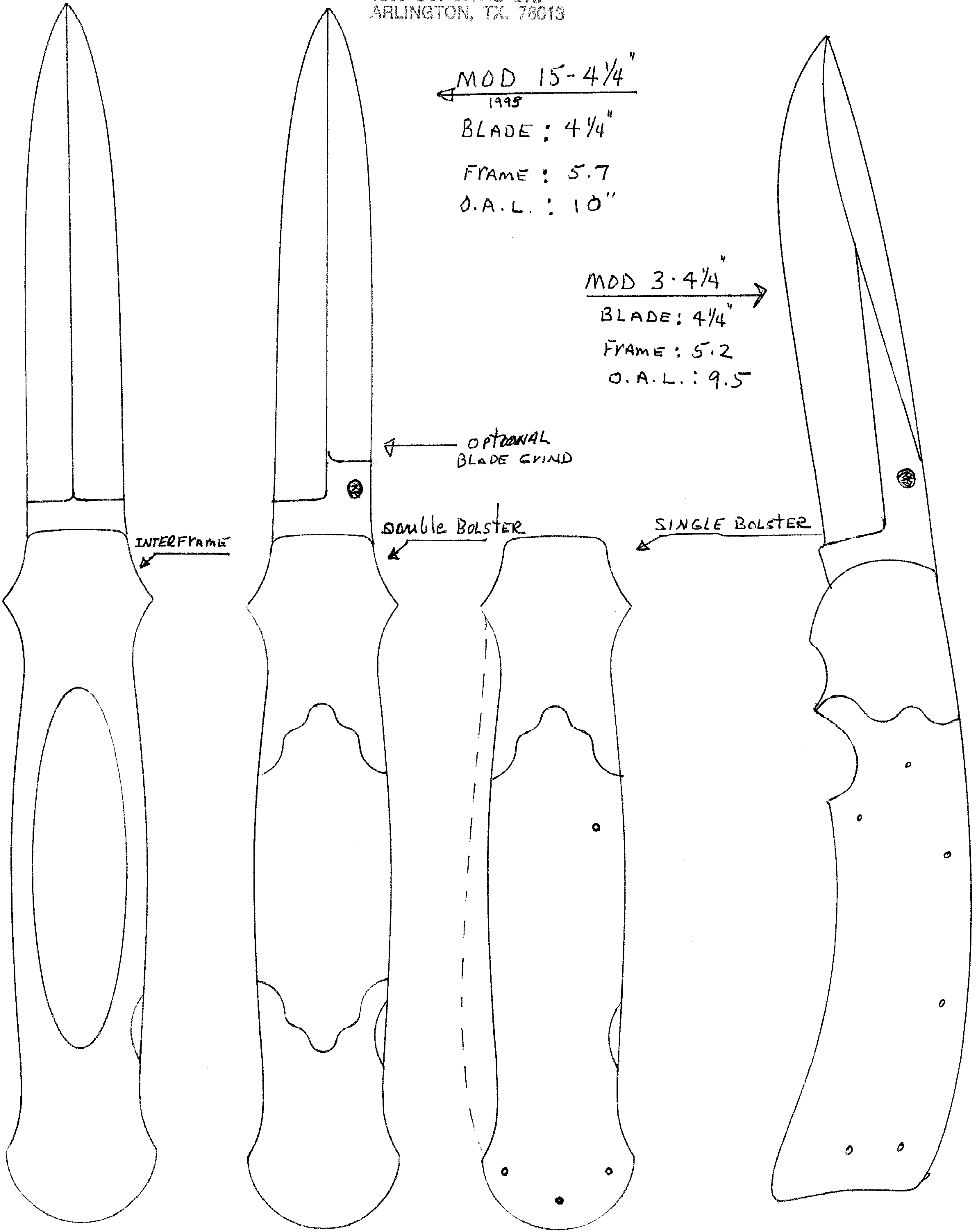

MOD. 17

MAR 97-NEW-

PG. 6

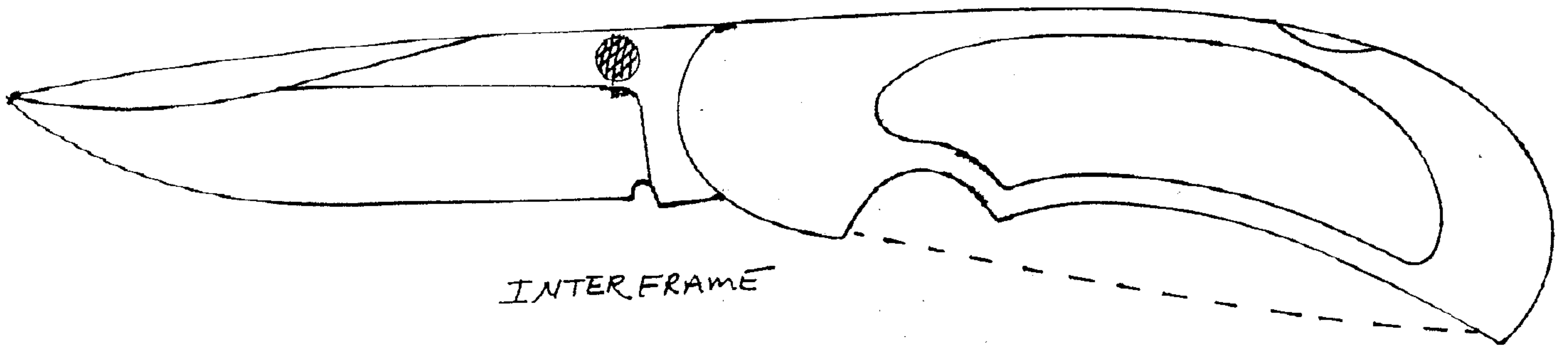

INTERFRAME

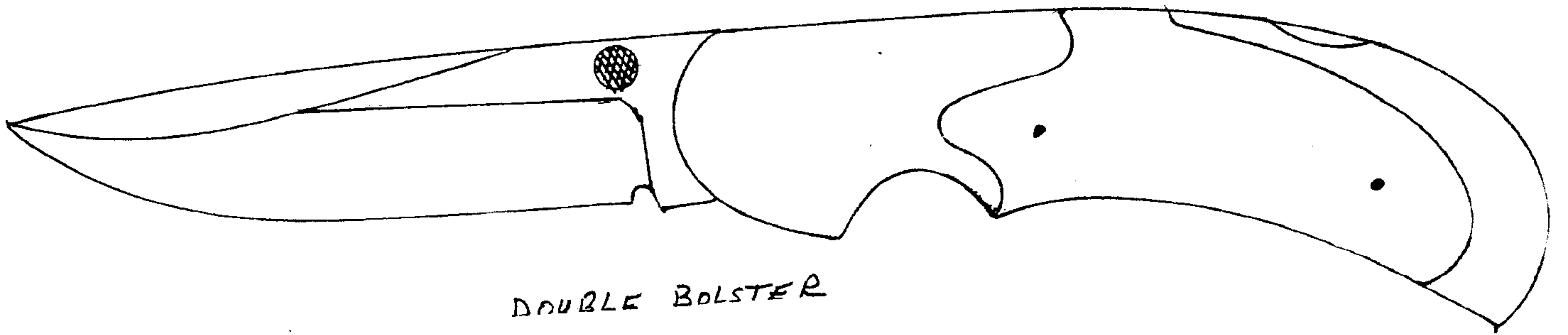

DOUBLE BOLSTER

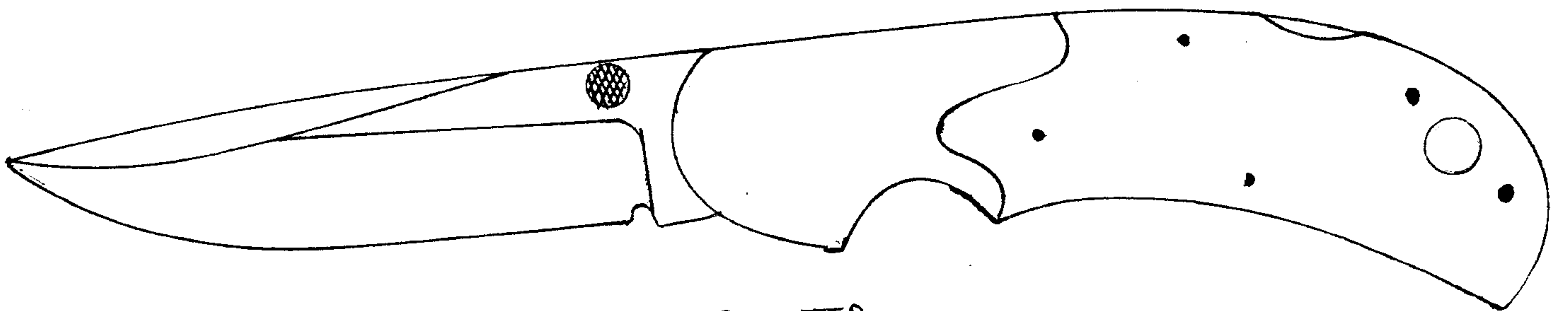

SINGLE BOLSTER

3.125 BLADE

FRAME: 4.2

OAL 7.200

MOD 18

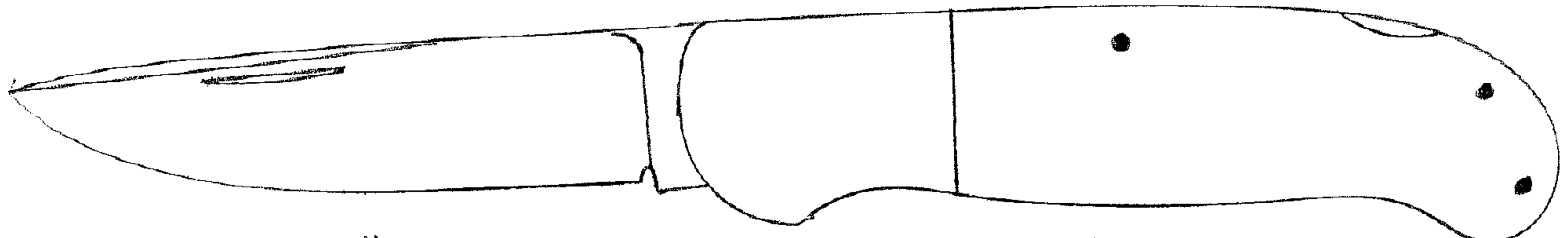

2.8" BLADE LENGTH

BOLSTER

6.6 O.A.L.

FRAME: 3.75

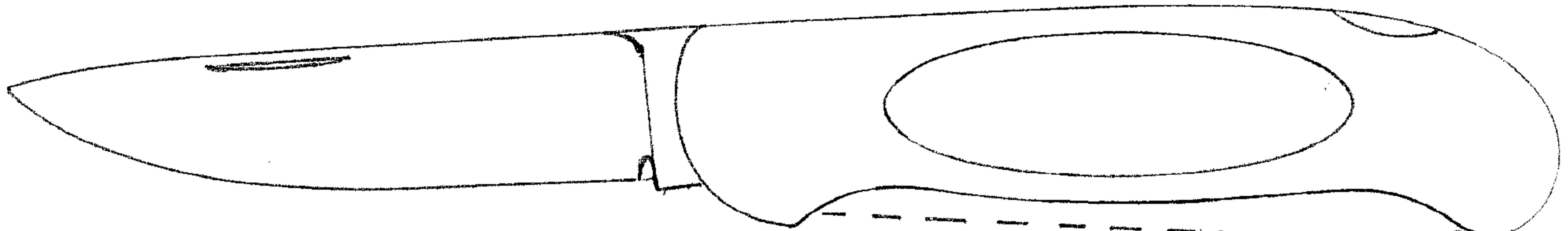

INTERFRAME

MOD 19

NEW IN 2000

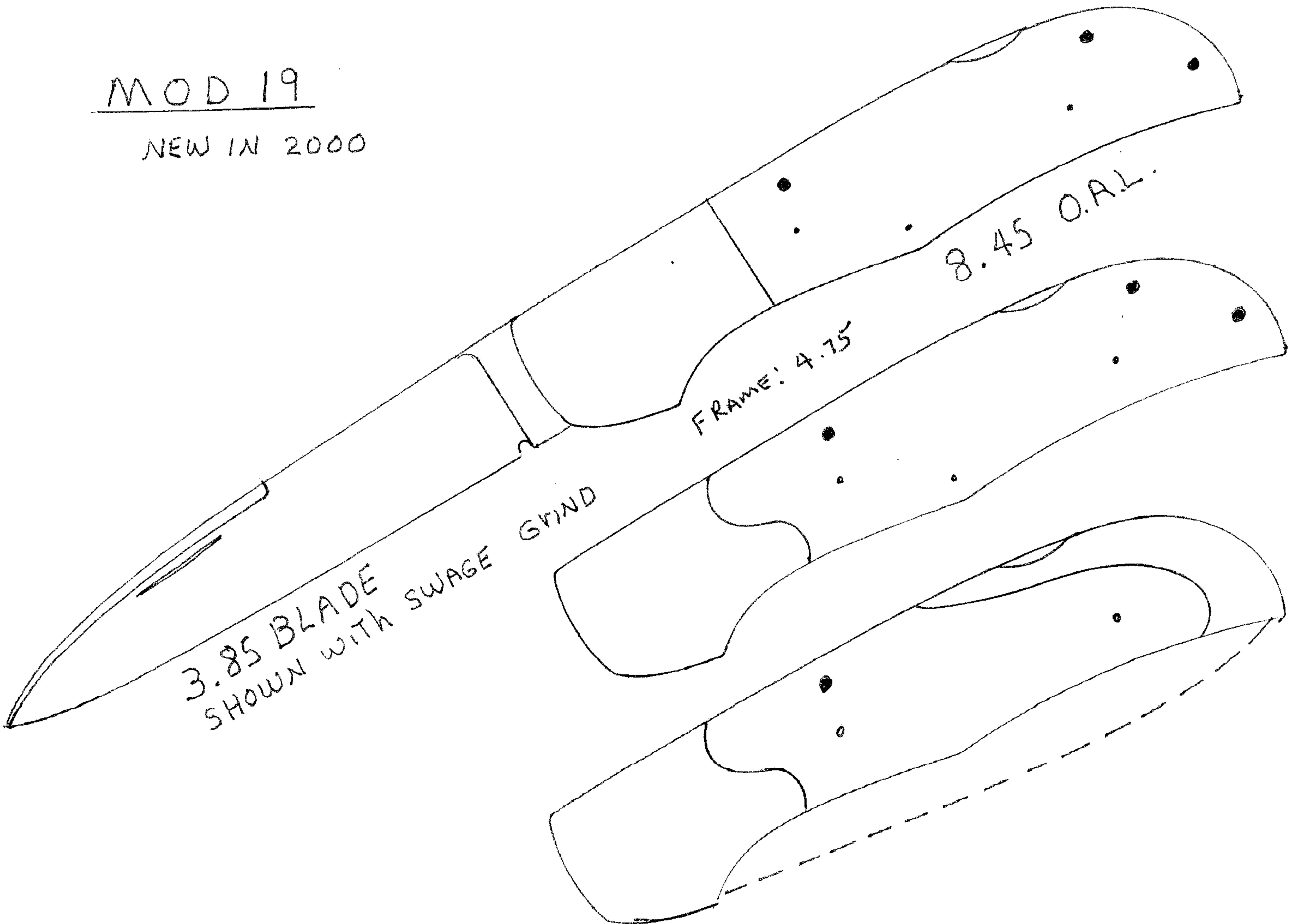

3.85 BLADE
SHOWN WITH SWAGE GRIND

FRAME: 4.75

8.45 O.A.L.

MOD 20 TRAPPER
NEW IN 2000

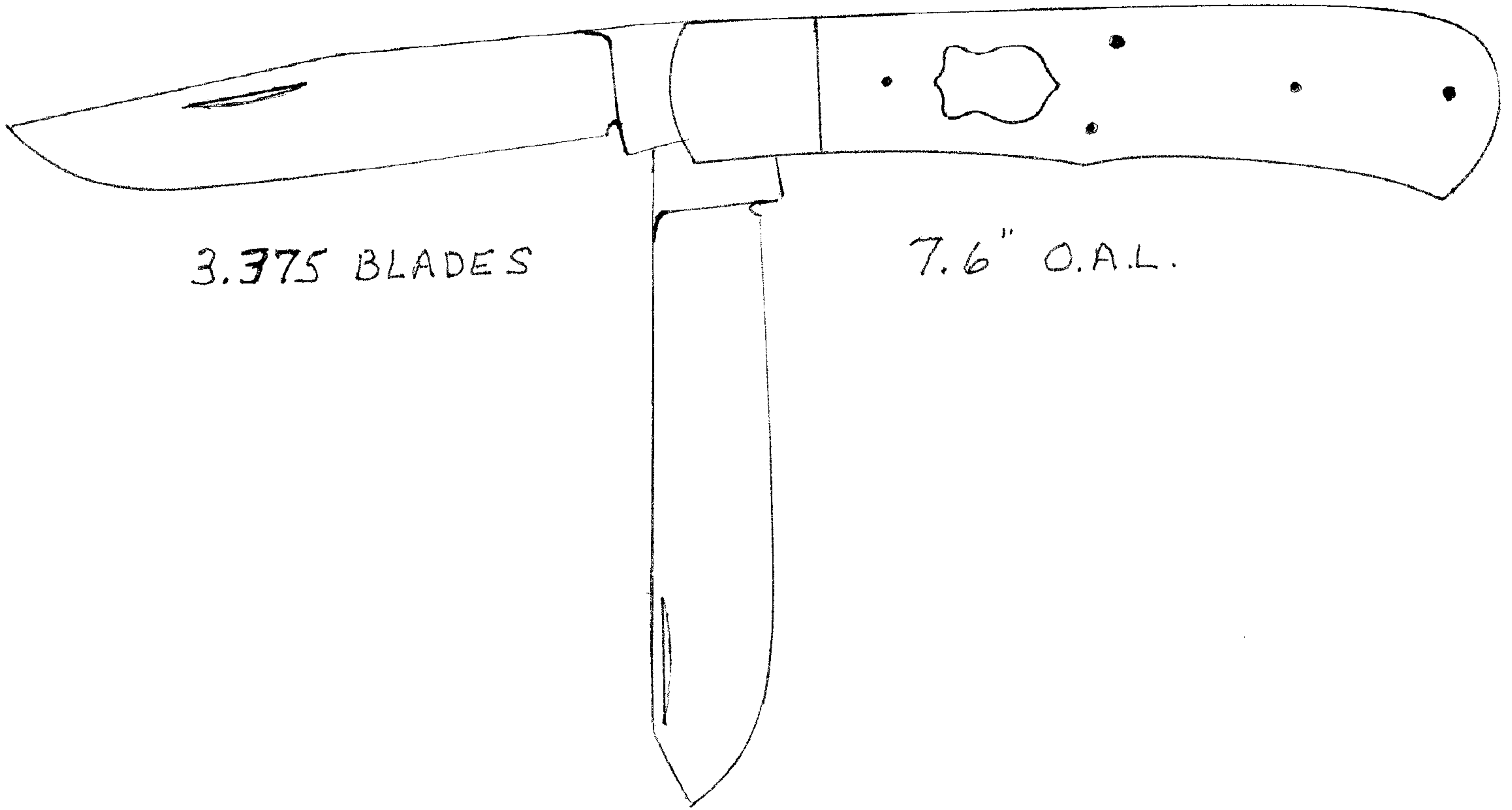

3.375 BLADES

7.6" O.A.L.

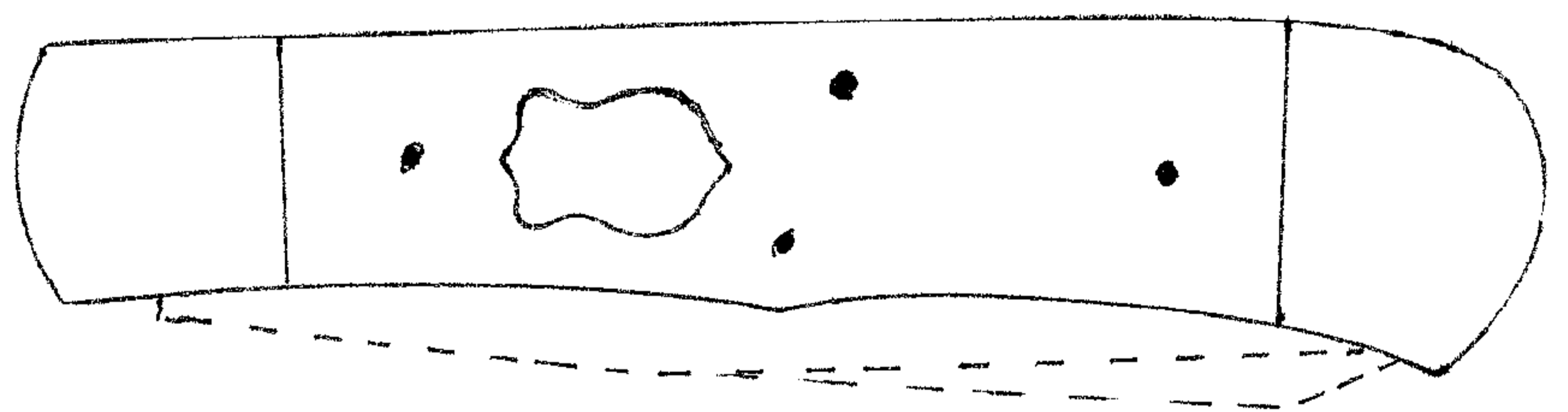

4.25 CLOSED

PG 9

MOD. 21 DOCTOR'S KNIFE

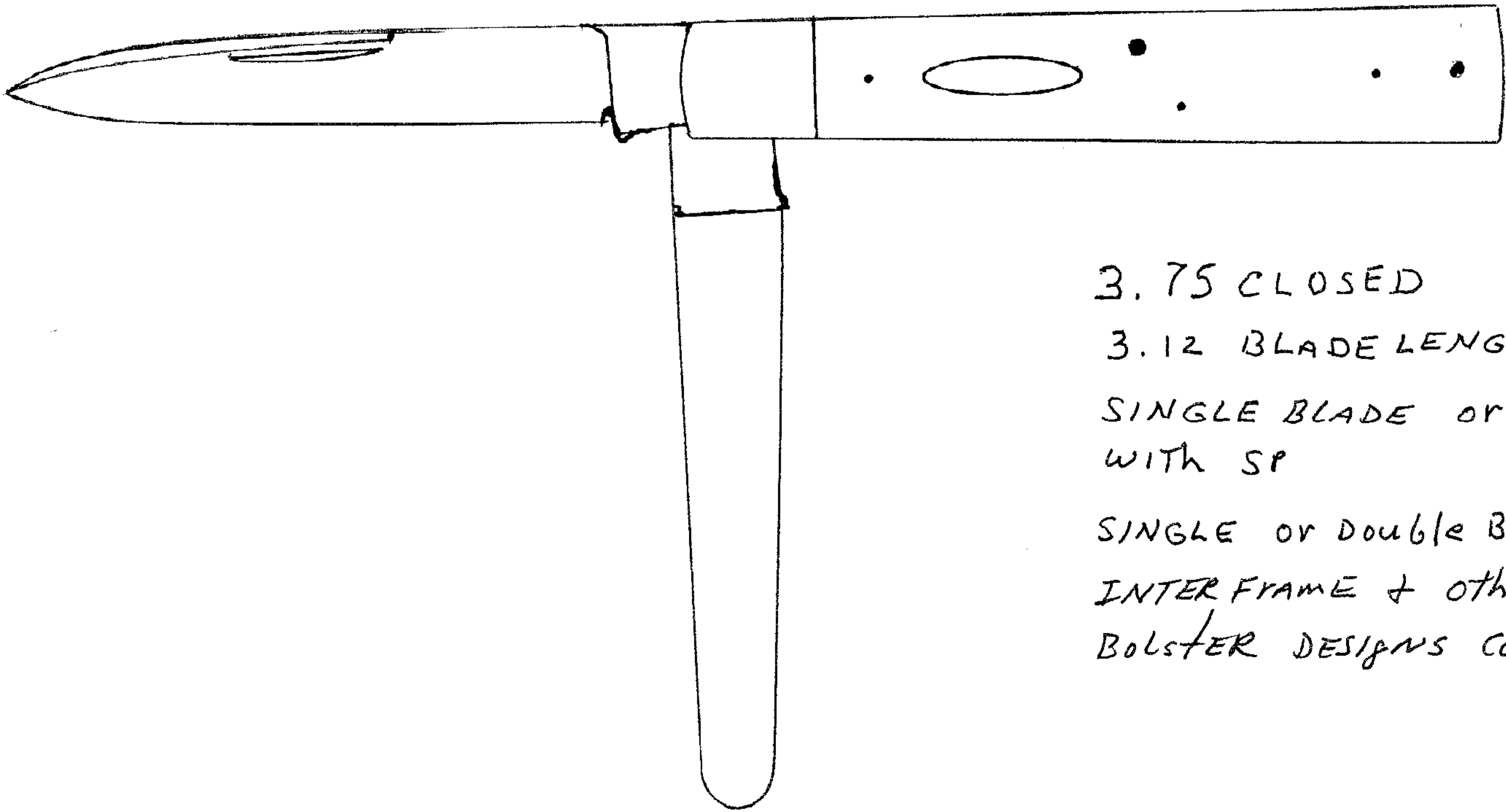

3.75 CLOSED
3.12 BLADE LENGTH
SINGLE BLADE OR
WITH SP
SINGLE OR DOUBLE BOLSTER
INTERFRAME + OTHER
BOLSTER DESIGNS COMING



"BELL"
SHAPE
BOLSTERS

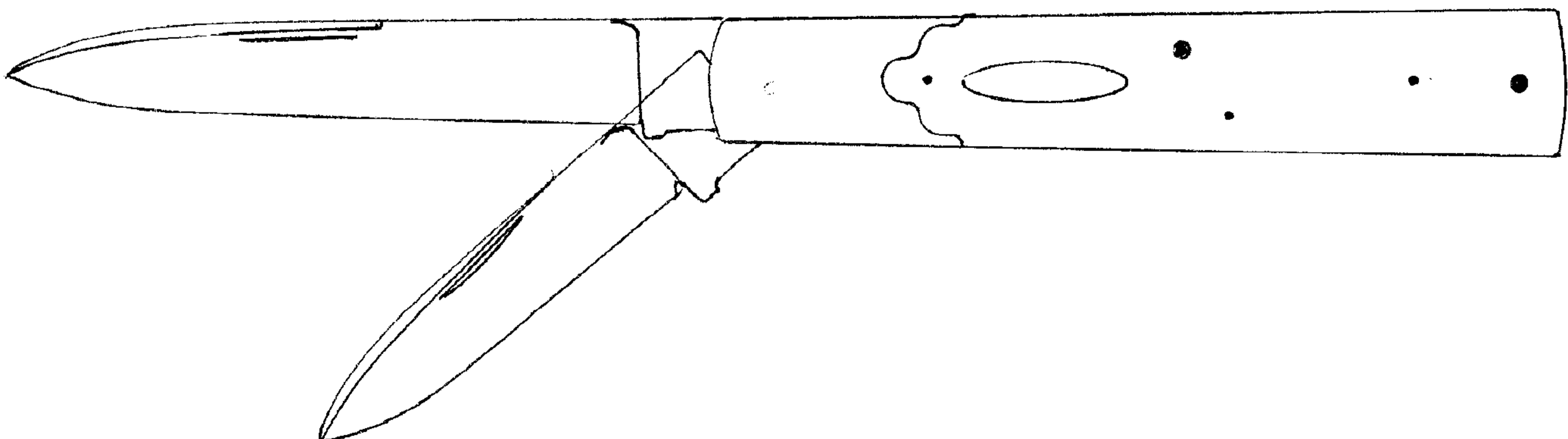
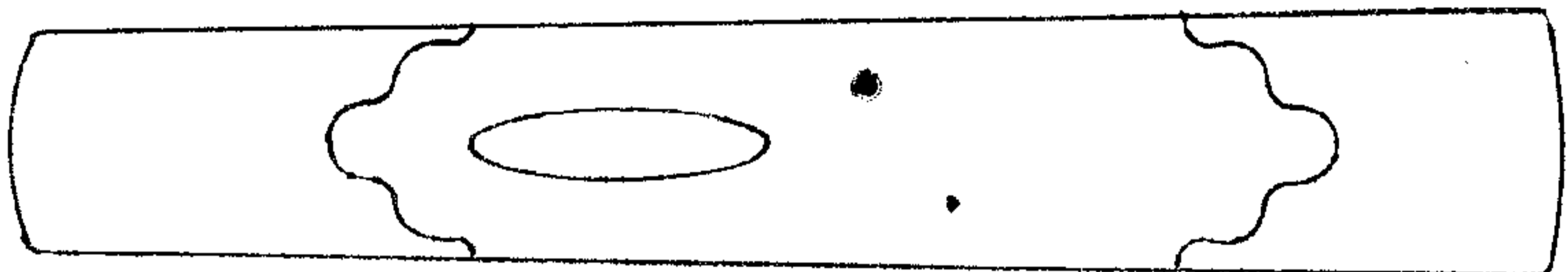

PG 10

MOD. 22 GUNSTOCK

NEW IN 2002

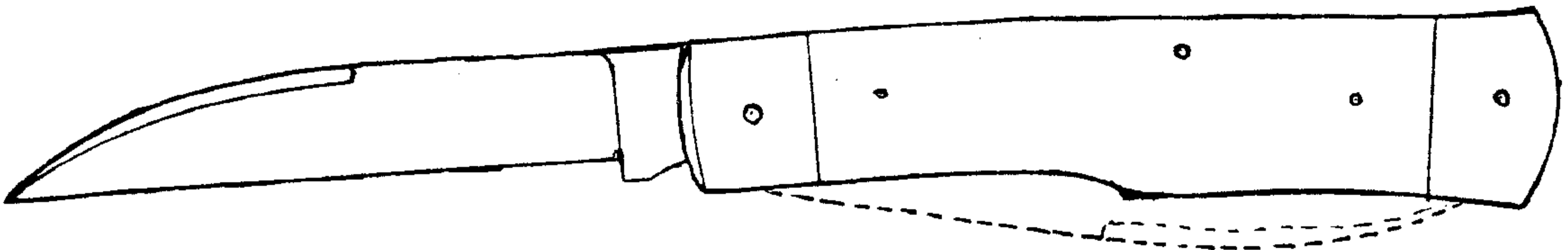
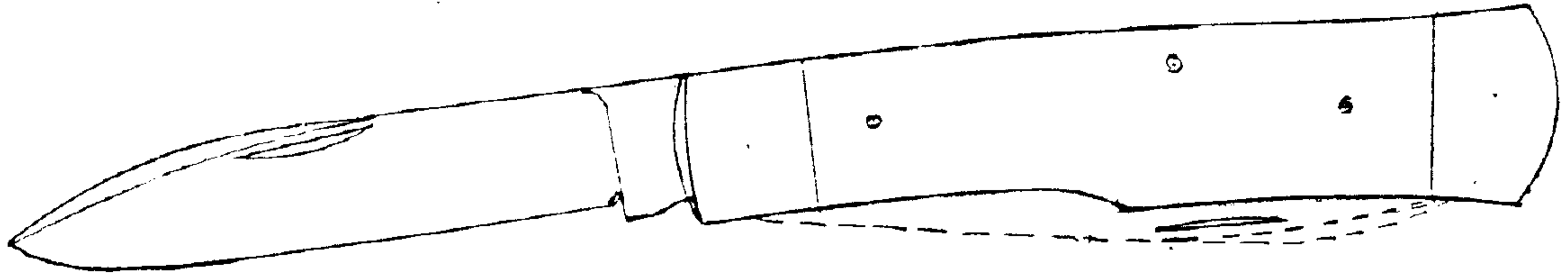

2.5" BLADES
SINGLE OR DOUBLE BLADE
SINGLE OR DOUBLE BOLSTERS

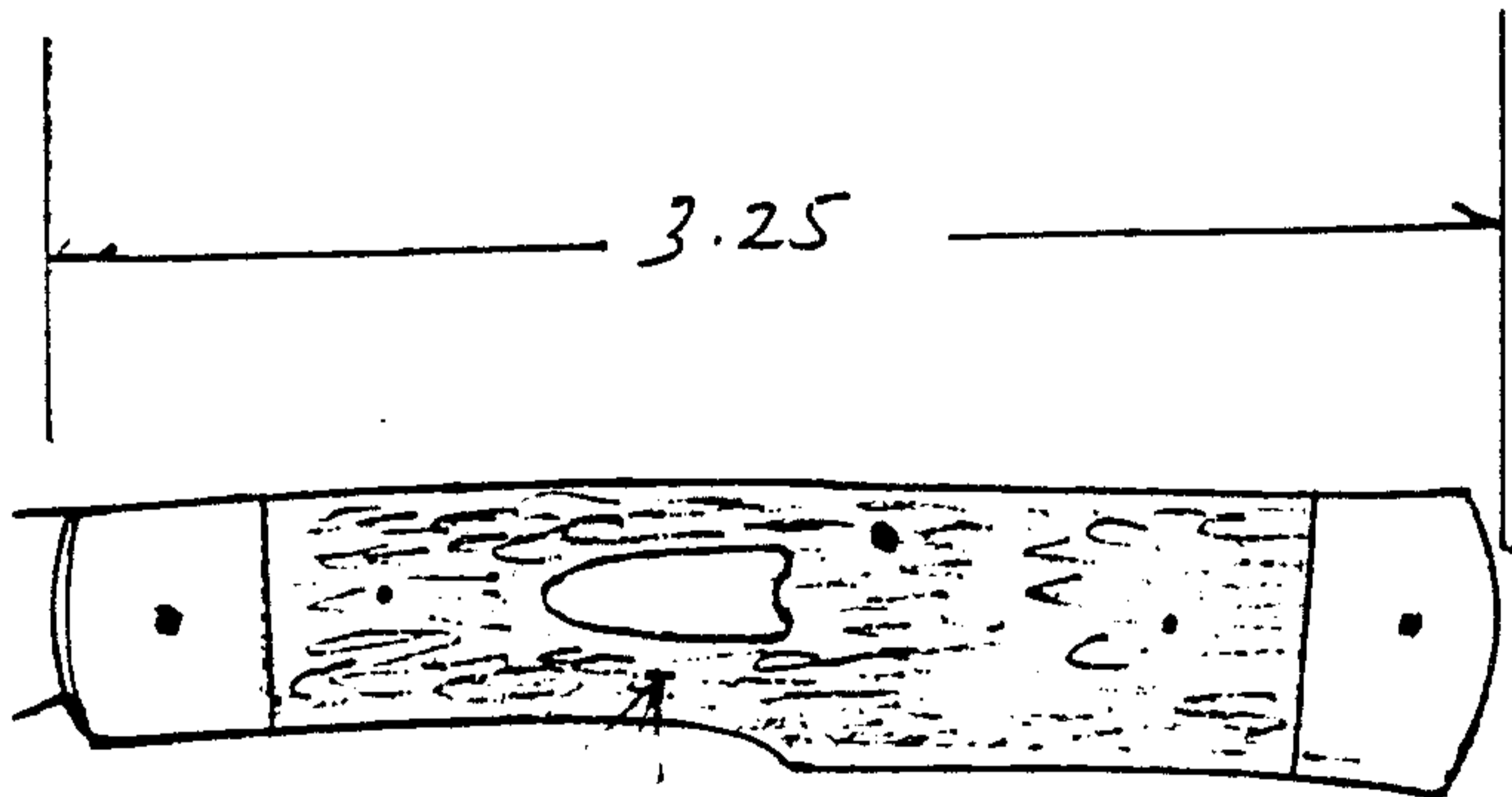

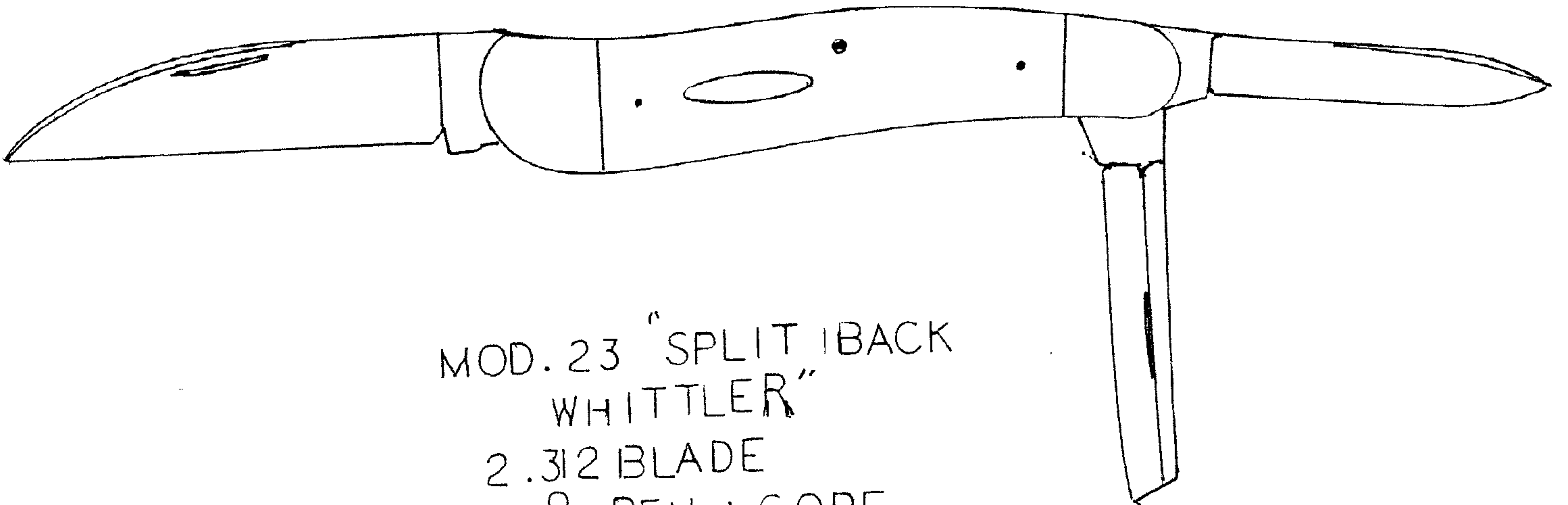

MOD. 23 "SPLIT BACK
WHITTLER"
2.312 BLADE
1.8 PEN & COPE
3.437 CLOSED
2.4 oz Approx weight

MOD 24 "JACK"

BASED ON CASE 6214

THANKS TO TONY BOSE

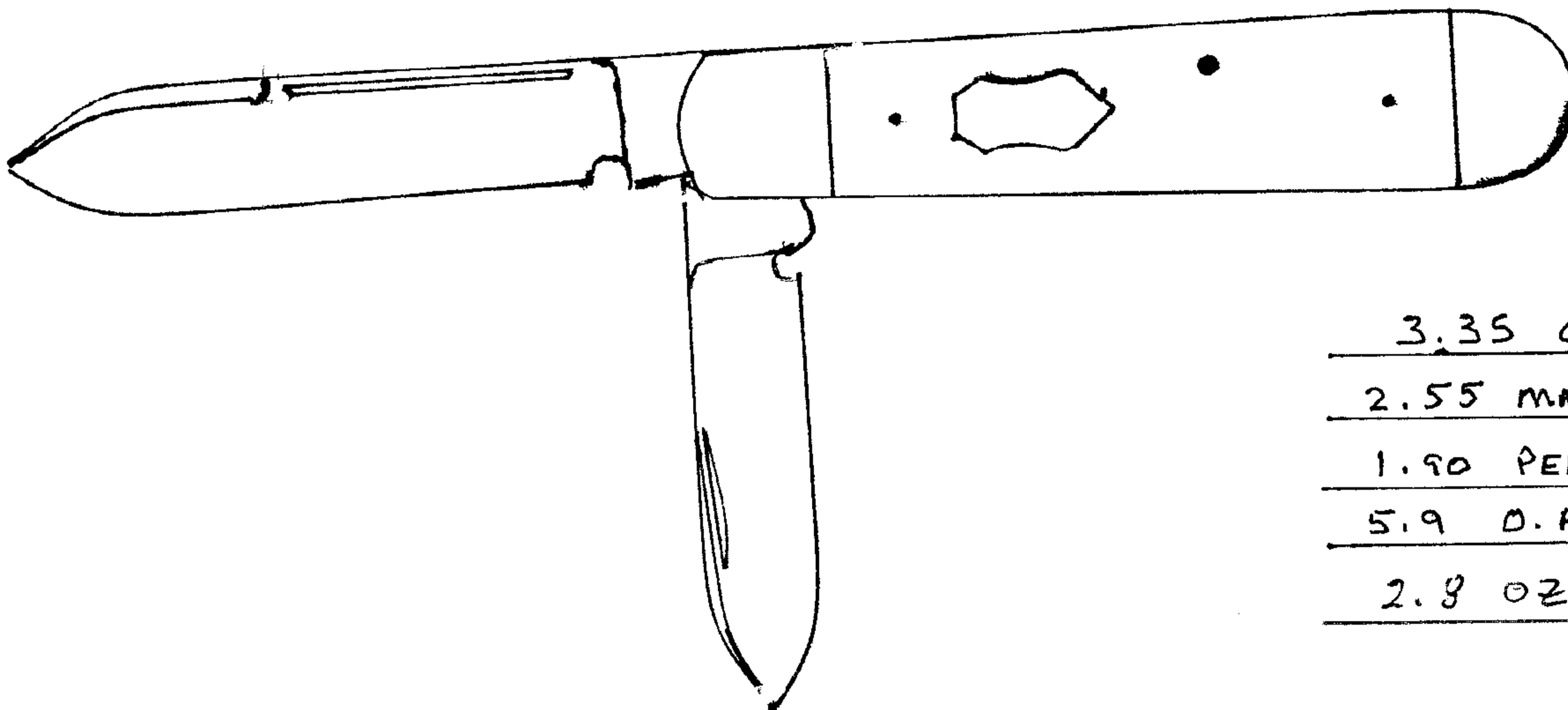

3.35 CLOSED

2.55 MASTER BLADE

1.90 PEN BLADE

5.9 O.A.L.

2.8 OZ APPROX.

MOD. 26 "SERPENTINE TRAPPER"

THANKS TO TONY BOSE

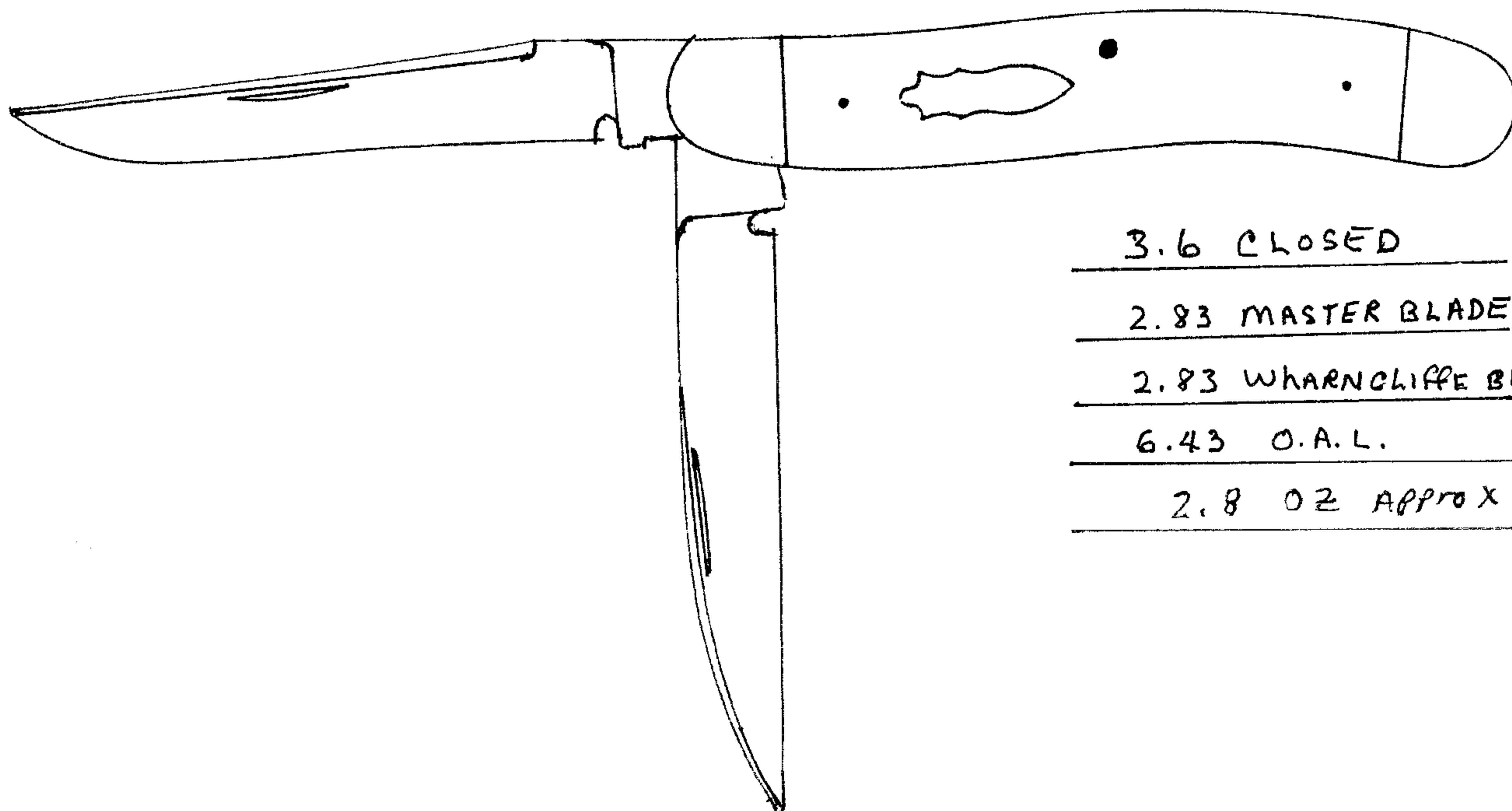

3.6 CLOSED

2.83 MASTER BLADE

2.83 WHARNCLIFFE BLADE

6.43 O.A.L.

2.8 OZ APPROX

T. R. OVEREYNDER KNIVES

MODEL 25 "DAGGER"

MAY 2005

SMALL OVAL 2"

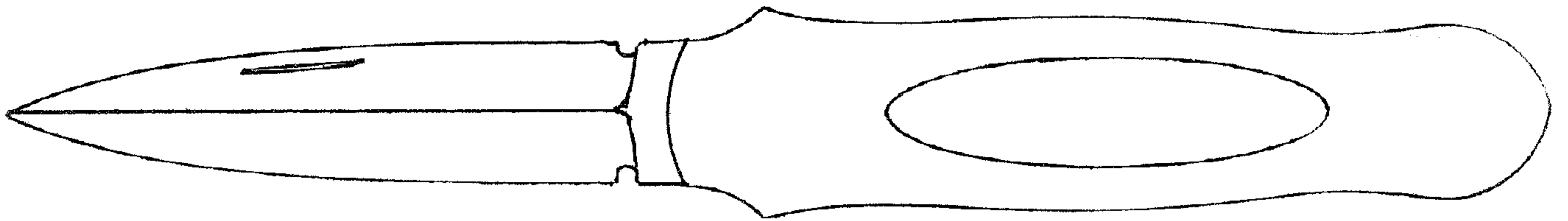

DIMS:

- BLADE LENGTH: 3.0"
- CLOSED LENGTH: 3.975"
- OVERALL OPEN: 6.975"
- APPROX WEIGHT: 3.4 OZ

LARGE OVAL 2.375

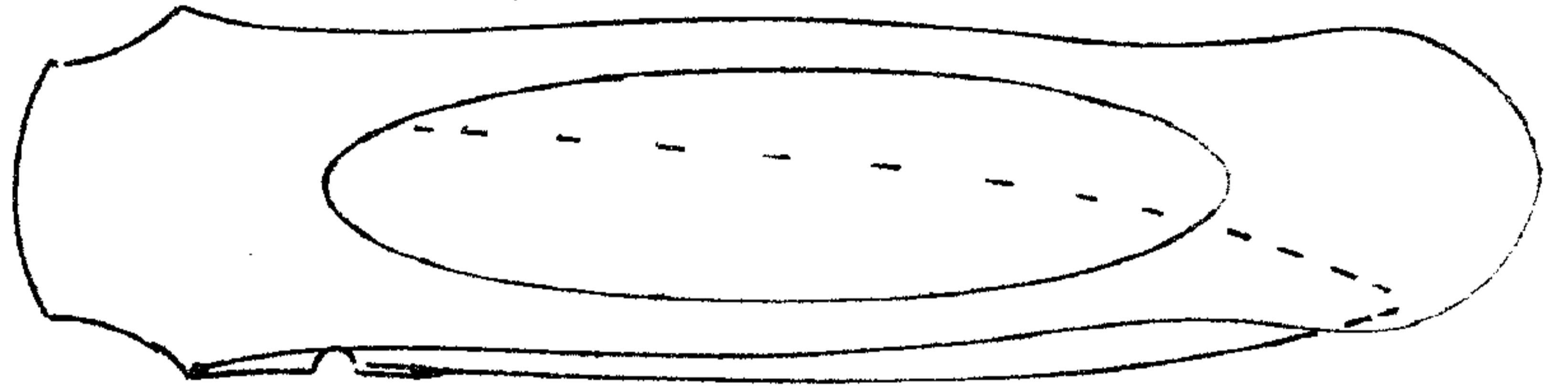

DOUBLE OVAL SIMI-INTERFRAME

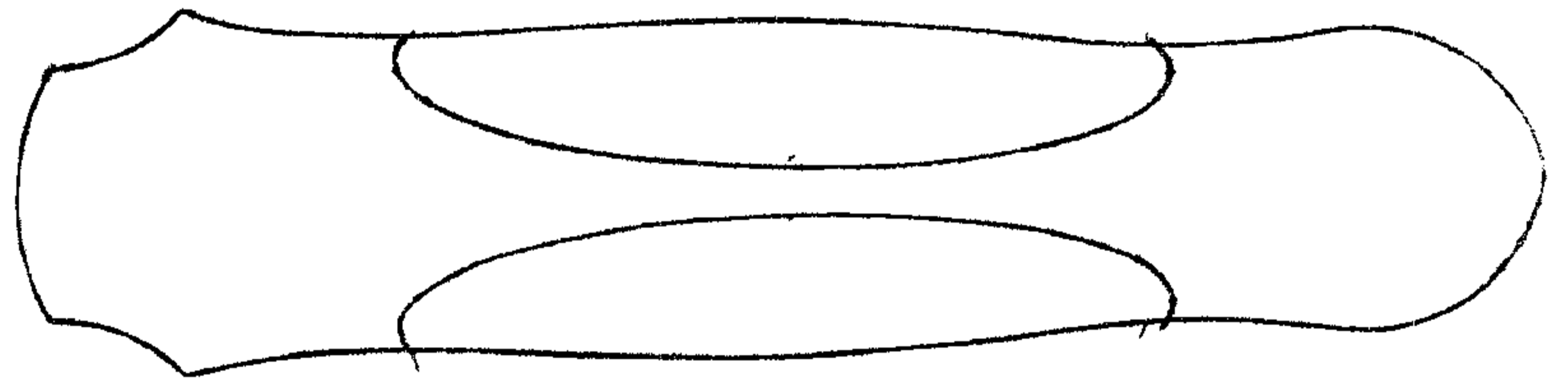

SADDLE HORN MODEL 27

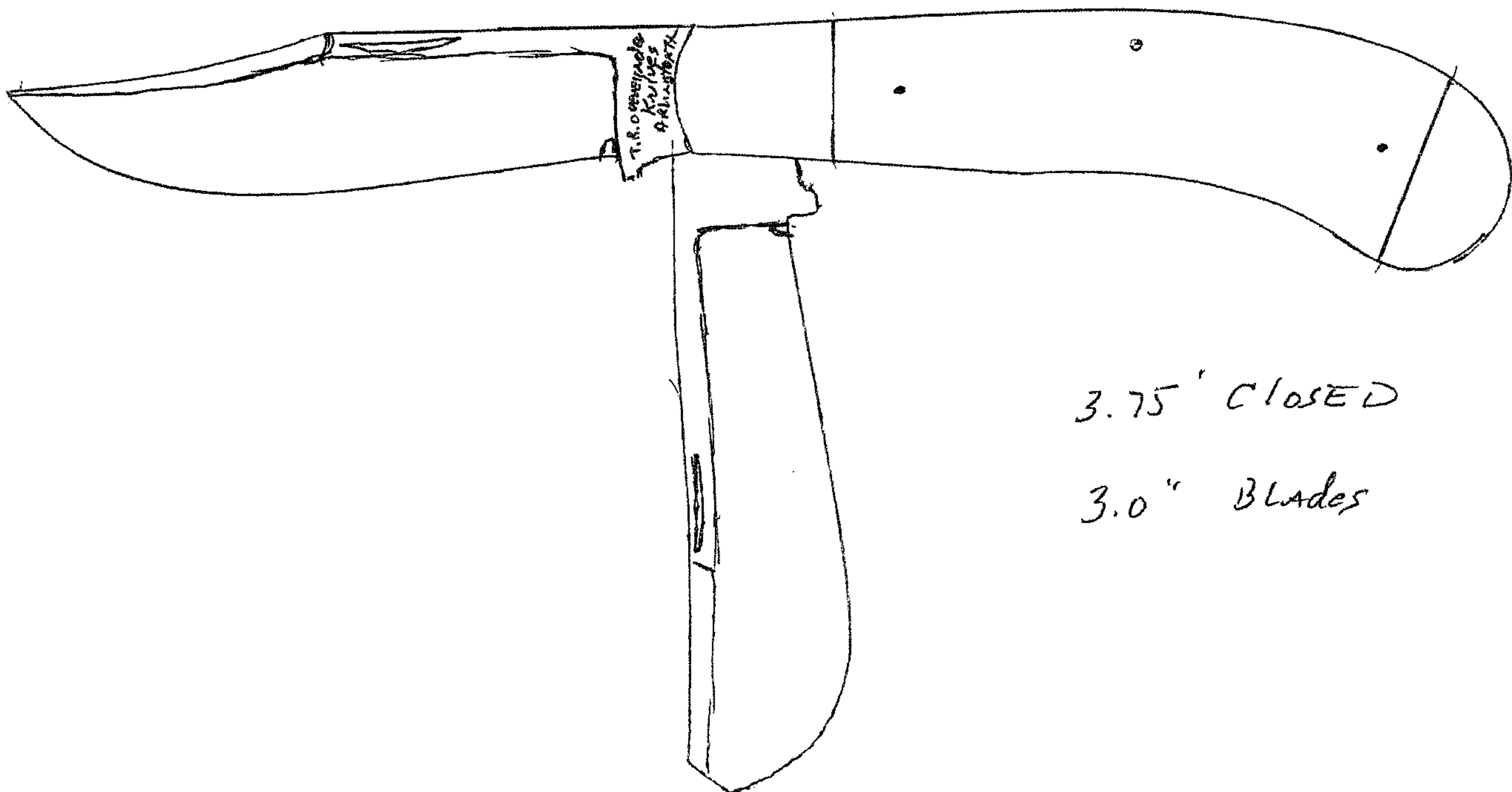

3.75" CLOSED

3.0" BLADES

MODEL 29 "Lockback Whittler"
2012

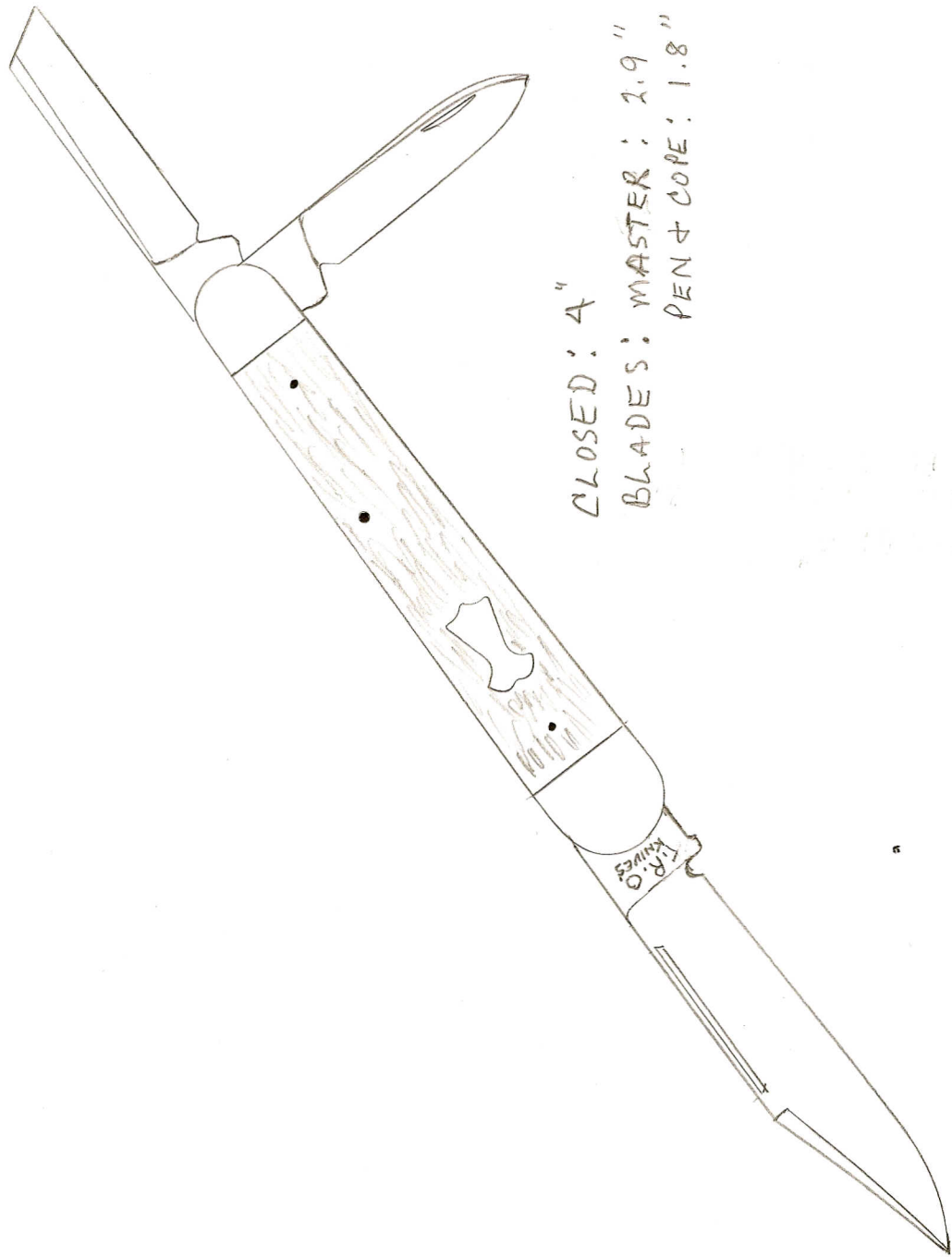

CLOSED: 4"

BLADES: MASTER: 2.9"

PEN & COPE: 1.8"

T. R. OVEREYNDER KNIVES

MODEL 30 "DAGGER"

JAN 2011

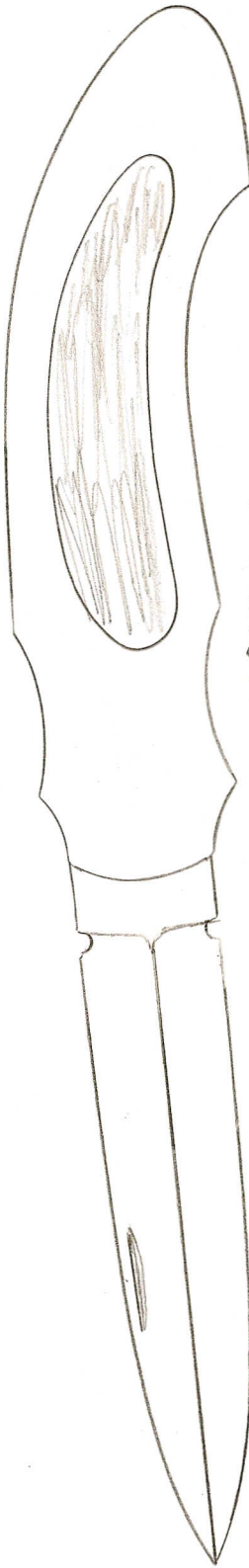

SINGLE + 2 PIECE INTERFRAME OPTIONS

BLADE LENGTH: 3.7"
OPEN OAL: 8.1"
CLOSED: 4.5"

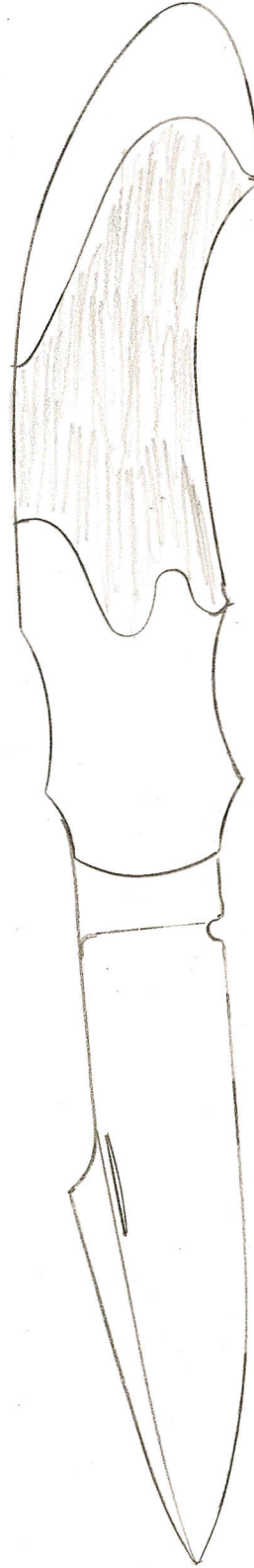
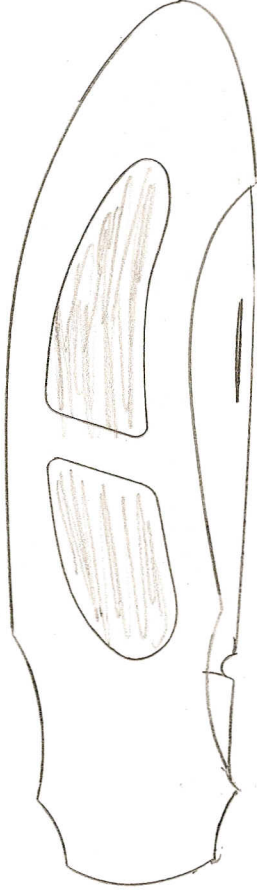

"TOP NOTCH DAGGER" OPTIONAL BLADE SEMI-INTERFRAME OPTION

T. R. QUEREYNDER KNIVES.COM

MODEL 33 "SOWBELLY"
MAY 2011

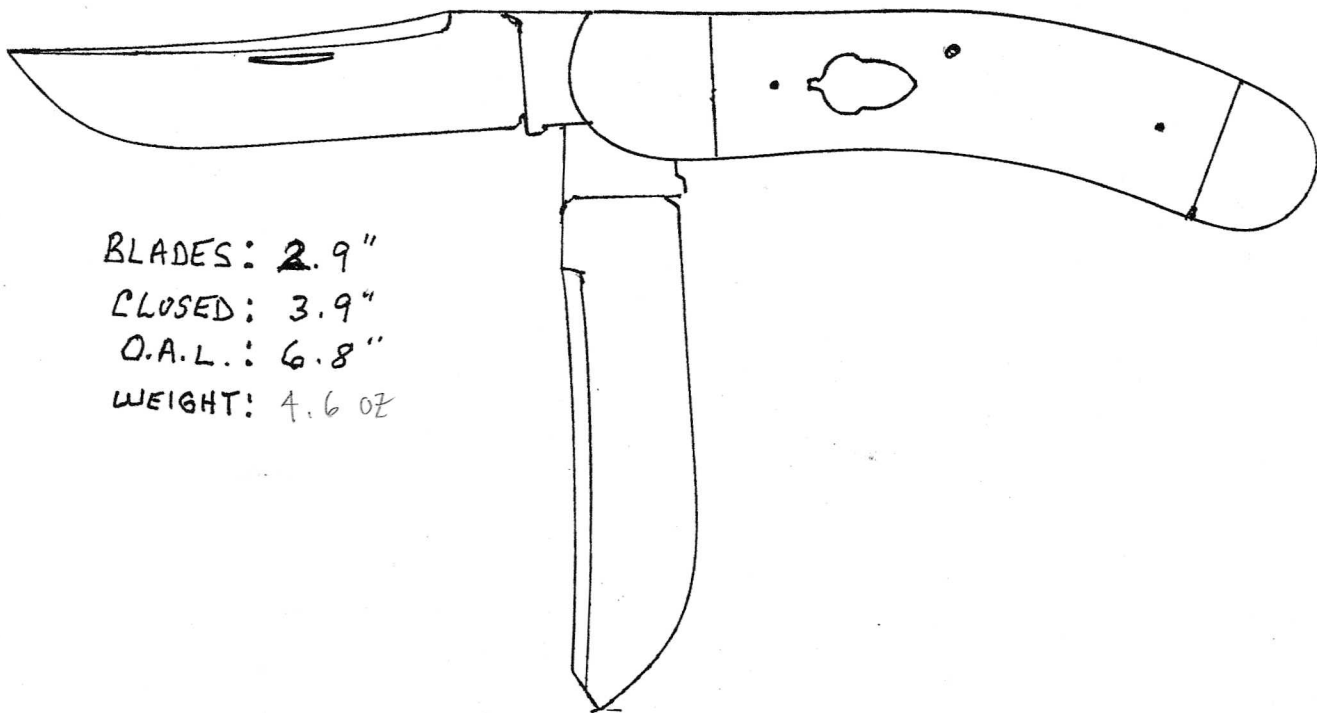

BLADES: 2.9"
CLOSED: 3.9"
O.A.L.: 6.8"
WEIGHT: 4.6 OZ

T.R. OVEREYNDER KNIVES.COM

MODEL 34 "BIG JACK"

MAY 2011

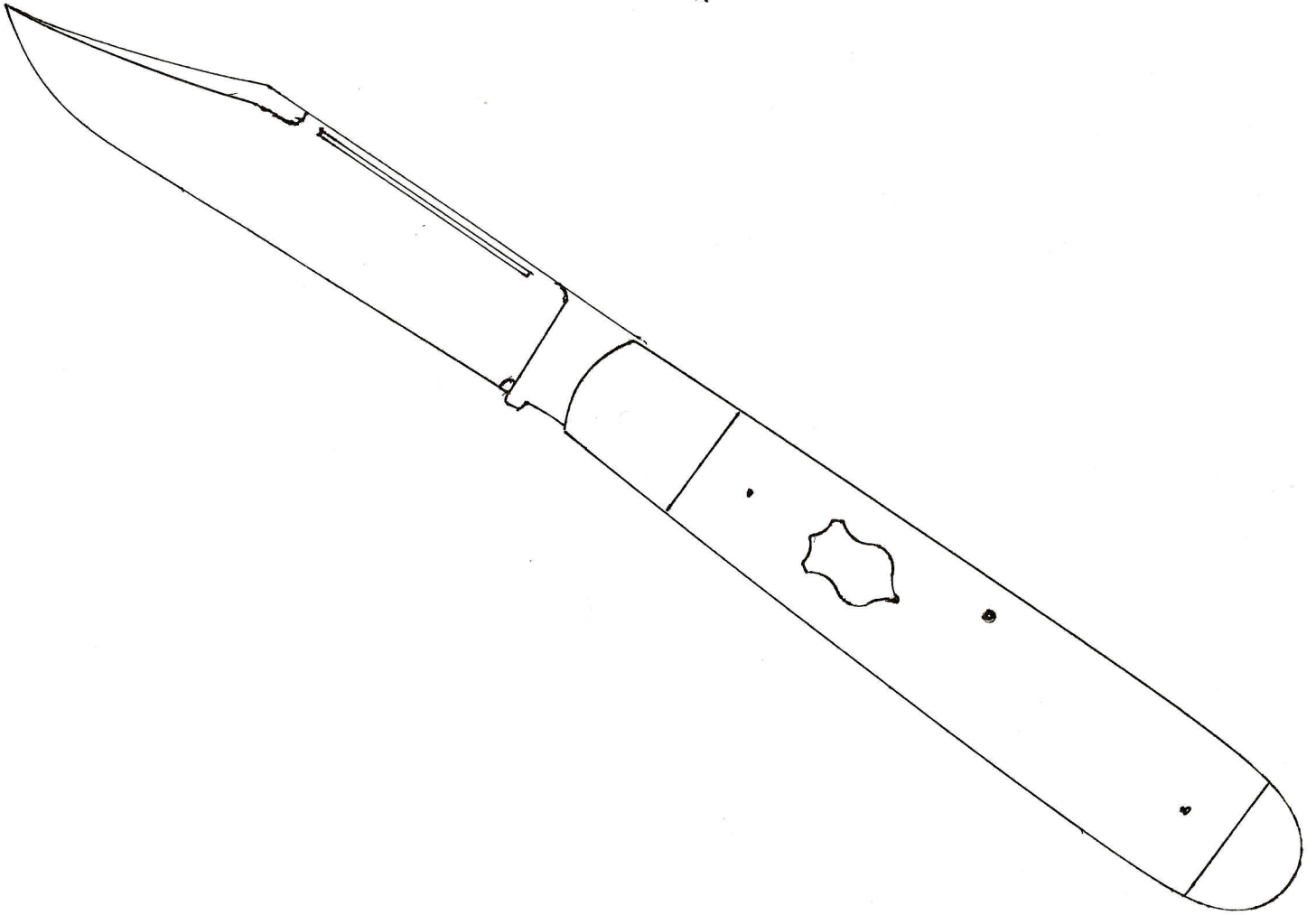

BLADE: 4.05"

CLOSED: 5.0"

O.A.L.: 9.0"

WEIGHT: 4.6 OZ